

**ATTEN**

**ST-1101 ST-1101D**  
**ST-1202 ST-1202D**

**焊锡烟雾净化器**

**FUME EXTRACTOR**

**ST-1101 ST-1101D**  
**ST-1202 ST-1202D**

**ATTEN**



Read all instructions before using the appliance and retain for future reference.

- This product should never be used/placed at high temperature, high humidity or in a flammable, explosive and strong electromagnetic environment.
- When not in use for extended periods, switch the appliance off and disconnect from the mains.
- This product is high voltage inside. All repairs should only be carried out by a qualified engineer. Improper repairs may place the user at risk of harm.
- To avoid any damage, when the impeller rotates at high speed, do not touch it with hands or objects.

### Caution

- The smog suction's effect is affected by the distance between the smog suction hood and the point of smog generated directly. Tests proved that the best distance is maintained at 10-15cm.
- If air flow speed surrounding the smog suction hood is fast, the smog suction effect will be worse. Need to reduce the air flow.
- The longer length of smog suction pipes, the weaker effect of smog suction. The more smog suction pipe bends, the worse effect of smog suction. Recommendation: Minimize the pipe bends as much as possible.

### Filter Element Replacement

This product relies on a variety of filter cartridge parts to achieve filtering the smog, smell, toxic substances. Therefore, the filter element parts as consumptive material, with the amount of saturation, should be replaced on a regular basis.

Recommended replacement cycle:

Primary filter: 10-15 days

Medium efficiency filter: 3-6 months

Main filter: 6-9 months

The replacement period depends on the actual situation, i.e. different amounts of pollution generated in different places. Please pay attention to the use and maintenance of the machine specified above, and replace the filter element parts regularly.

Otherwise, it will lead to reduced suction, equipment damage, early scrapping of filters and environmental pollution accidents and personal injury, which are not within the scope of our company's responsibility.

## 安全注意事项

感谢您使用本公司的产品,在使用前,请您仔细阅读本手册并注意手册中提及的相关警告及注意事项

### 安全规则

- 本产品绝不能在高温、高湿、易燃、易爆和强电磁环境下储存或使用。
- 长时间不使用时,请断开电源,保持机器开关处于关闭状态。
- 内部有高压,禁止非专业人士拆卸或修理。
- 叶轮高速旋转时,禁止用手或物体接触,以免机械损坏。

### 注意事项

- 吸雾效果受吸雾罩与直接产生烟雾点之间的距离影响。多次试验证明,最佳距离保持在10-15cm。
- 如果吸烟罩周围的气流速度快,就会造成吸烟效果不佳。需要把风量调低。
- 吸烟管长度越长,吸烟效果越弱。吸烟越多 管道弯曲,吸烟效果更差。  
建议:尽量减少管道弯曲,如果不能避免弯曲,也要尽量减少。

### 滤芯更换

本产品依靠多种滤芯部件实现对烟雾、异味、有毒物质的过滤,因此滤芯零件作为消耗性材料,具有饱和量,应定期更换。

建议更换周期为:

初滤棉:10-15天

中效滤芯:3~6个月

高效滤芯:6-9个月

更换周期取决于实际情况,即不同地方产生的不同污染量。请注意使用和维护以上规定的机器,定期更换滤芯部件;否则,将导致流量变小、设备损坏、过滤器提前报废,以及造成环境污染事故和人身伤害,这些不属于我公司的责任范围。

## 包装清单

打开包装箱取出主机后, 请仔细检查以下内容是否缺失或损坏。如果发现有任何物品缺失或损坏, 请与本公司或经销商的客户服务联系。

名称	数量	备注
净化器主机	1	
电源线	1	
竹节管	2	单工位只配一个
硅胶吸烟罩	2	单工位只配一个
说明书	1	
初效过滤棉	4	
滚轮	4	ST-1101和ST-1202不标配
脚垫	4	
PVC导风管	1	

## 技术参数

型号	ST-1101	ST-1101D	ST-1202	ST-1202D
电压	230V,110V	230V,110V	230V,110V	230V,110V
工位数	单工位	单工位	双工位	双工位
系统流量(含过滤装置)	240m <sup>3</sup> /H(±10%)	240m <sup>3</sup> /H(±10%)	150m <sup>3</sup> /H*2(±10%)	150m <sup>3</sup> /H*2(±10%)
过滤效率(0.3微米)	99.97%	99.97%	99.97%	99.97%
功率	160W	160W	180W	180W
显示	旋钮	显示屏	旋钮	显示屏
噪音	45-60dB(A)(Max)	45-60dB(A)(Max)	45-60dB(A)(Max)	45-60dB(A)(Max)
联机功能(联接焊台使用)	无	有	无	有
流量传感器	无	有	无	有
外接控制器或遥控器	无	有	无	有
滤芯堵塞声光报警	无	有	无	有
竹节管	1.3m可定制长度	1.3m可定制长度	1.3m可定制长度	1.3m可定制长度
出风接口	φ75mm	φ75mm	φ75mm	φ75mm
外形尺寸(主机)	465x250x480mm	465x250x480mm	465x250x480mm	465x250x480mm
重量	17kg	17kg	18.2kg	18.2kg

Parts Name	Quantity	Remark
Extractor host	1	
power cable	1	
Flexi tube	2	Only one for single Channel
Silicone funnel nozzle	2	Only one for single Channel
User manual	1	
Primary filter	4	
Roller	4	Not for ST-1101 and ST-1202
Machine foot pads	4	
PVC duct pipe	1	

Packing list  
After unpacking and taking out the host, please carefully check whether the following contents are missing or damaged. If you find any items missing or damaged, please contact the customer service center of our company or dealer.

Model	ST-1101	ST-1101D	ST-1202	ST-1202D
Voltage	230V,110V	230V,110V	230V,110V	230V,110V
Work position	1	1	2	2
System flow (including filtering equipment)	240m <sup>3</sup> /H(±10%)	240m <sup>3</sup> /H(±10%)	150m <sup>3</sup> /H*2(±10%)	150m <sup>3</sup> /H*2(±10%)
Filteration efficiency (0.3 micron)	99.97%	99.97%	99.97%	99.97%
Power	160W	160W	180W	180W
Display	Knob	LCD screen display	Knob	LCD screen display
Noise	45-60dB(A)(Max)	45-60dB(A)(Max)	45-60dB(A)(Max)	45-60dB(A)(Max)
On-line function (used for connecting soldering station)	×	√	×	√
Air flow sensor	×	√	×	√
External controller or remote control	×	√	×	√
Audible and visual alarm of filter element blockage	×	√	×	√
Flexi tube	1.3m Length Customizable	1.3m Length Customizable	1.3m Length Customizable	1.3m Length Customizable
Air outlet interface	φ75mm	φ75mm	φ75mm	φ75mm
Overall dimension (host)	465x250x480mm	465x250x480mm	465x250x480mm	465x250x480mm
Weight	17kg	17kg	18.2kg	18.2kg

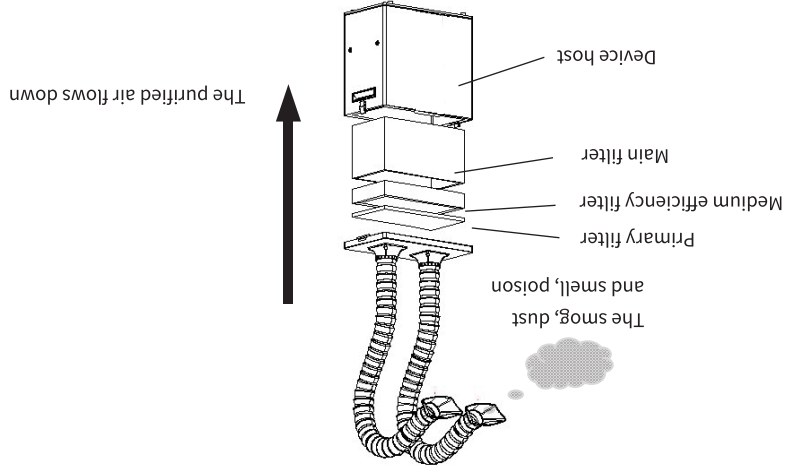

This purifier uses physical active purification filter. Pollutants are sucked in by vortex centrifugal fan, after being purified by multi-layer filtering device, the clean air is directly discharged into the room. (It can also be connected to smoke exhaust pipe to discharge the smoke and dust outdoors.)

### Operating principle

- 1.The appearance is simple and generous.The integrated design of the host adopts metal frame structure, which is durable.
- 2.Both sides are equipped with concave high-quality plastic handles, which is stable, reliable and easy to move.
- 3.Brushless DC motor and built-in controller are adopted to ensure performance and quality.
- 4.Limit governor is installed, the air volume and flow can be adjusted as needed.
- 5.The wind wheel is made of special alloy to effectively prevent corrosion. The unique dynamic balance correction technology makes the wind wheel run more stably and reliably. Large air volume, large suction, higher filtration rate.
- 6.Adopted triple filtration design. Filter layer by layer to ensure that harmful smoke and dust are filtered more thoroughly. The purification rate can reach 99.97%.
- 7.The primary, medium and high efficiency filter can be replaced separately, with longer service life and lower replacement cost.
- 8.Flexible tube can change direction and position as needed (the length can be customized). No need to lay additional pipes. Installation simple and convenient use.

### Product overview

### 产品概述

- 1.外观简洁大方。机身一体化设计，采用金属框架结构，持久耐用。
- 2.两侧装有内凹式优质塑胶拉手，稳重可靠，便于搬运。
- 3.采用直流无刷电机，内置控制器形式，性能、质量更有保障。
- 4.安装限位调速器，可随意调节风量及流量大小。
- 5.风轮采用特殊合金材质，有效防止被腐蚀。独有的动平衡校正技术，让风轮运行更平稳可靠。大风量，大吸力，过滤速率更高。
- 6.采用三重过滤设计。逐层过滤，确保有害烟尘被滤除得更彻底。净化率可达99.97%。
- 7.初、中、高效可单独更换，滤芯使用寿命更长，更换成本更低。
- 8.机器配以万向竹节管，可随意变向、定位（长度可定制）。安装简单，使用方便，无需另外铺设管道。

### 工作原理

净化设备采用物理活性净化过滤。污染物被涡流离心风机吸入。经多层过滤装置净化后，洁净空气直接排入室内。（亦可接入排烟管将烟尘排至室外）。

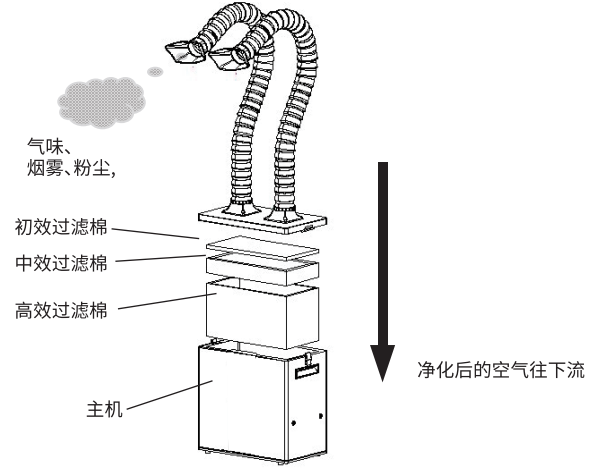

面板操作描述(ST-1101/ST-1202)

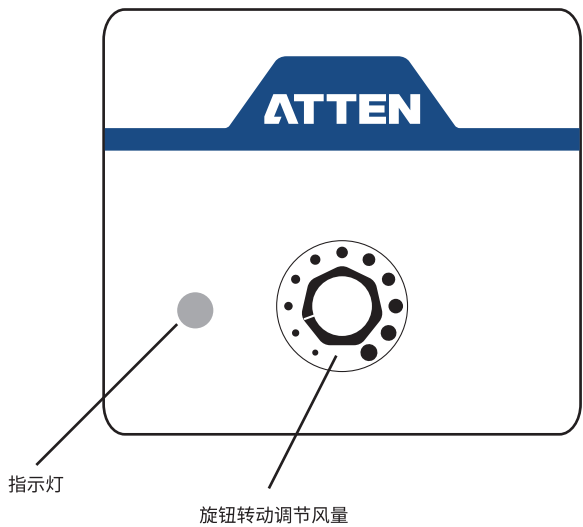

LCD显示描述(ST-1101D/ST-1202D)

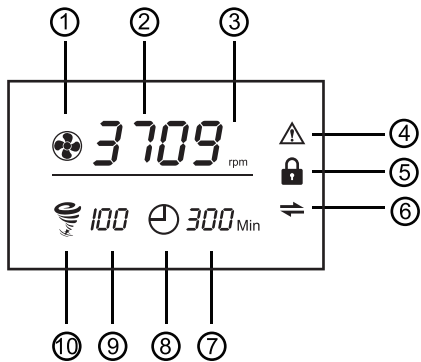

- ① 转速图标
- ② 转速大小
- ③ 单位
- ④ 报警图标
- ⑤ 面板锁定图标
- ⑥ 通讯连接图标
- ⑦ 定时工作时间
- ⑧ 定时工作图标
- ⑨ 风量等级大小
- ⑩ 风量等级图标

面板按键

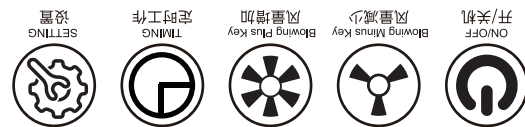

Panel buttons

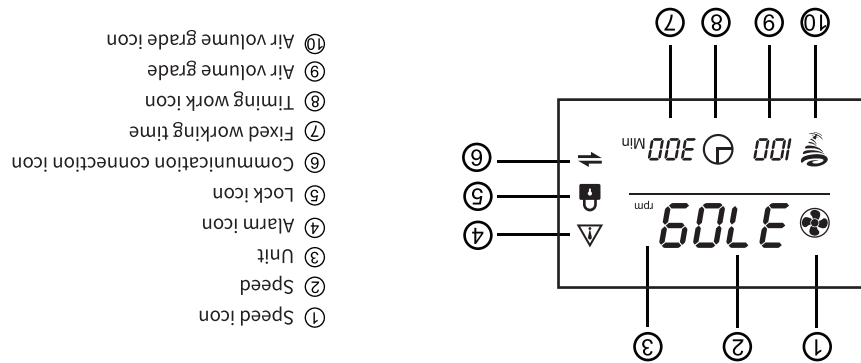

LCD display description(ST-1101D/ST-1202D)

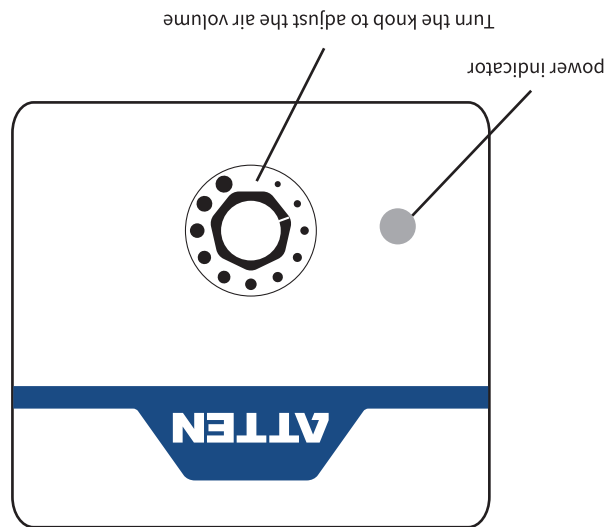

Knob operation description(ST-1101/ST-1202)

2. Air volume grade adjustment  
Click and to adjust the air volume (air volume grade range 1-100). Short press one time to adjust one unit air volume grade; long press to achieve fast adjustment. The air volume data displayed on the screen will also change accordingly.

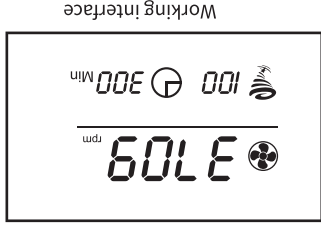

1. Connect the power supply and turn it on

**Operating Instructions (ST-1101D/ST-1202D)**

1. Connect the power supply and turn it on.  
2. Turn the knob to start the machine (the indicator light is on) and adjust the air volume.

**Operating Instructions (ST-1101/ST-1202)**

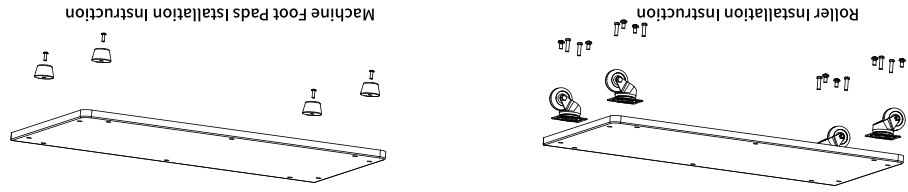

Silica gel cover installation instruction  
PVC duct pipe installation instruction  
3. Take out the smoke purifier and place it on a flat ground or table. Machines with casters need to lock the caster to avoid vibration or movement.  
4. Insert the flexi tube into the flange hole of the upper cover of the machine, adjust the collector hood so it is approximately 20cm from the source of the fume or smoke.

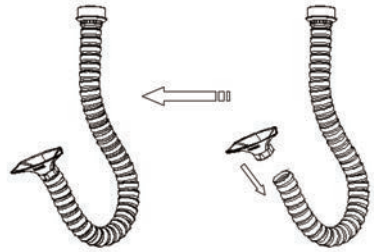
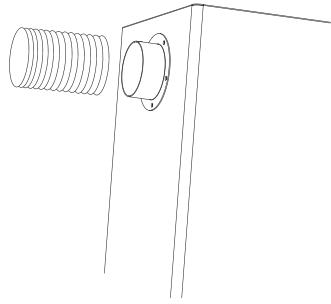

Connect the above components as shown below:

1. Open the packing box, take out the smoking pipe, primary filter and the host of the smoke purifier.  
2. The package bag of smoking pipe contains flexi tube, tube joint and silica gel cover.

**Product assembly**

**产品装配**

1. 打开包装箱，取出吸烟管（万向节），再取出初效过滤棉包装袋，最后拿出烟雾净化器主机。
2. 万向节吸烟管包装袋中包含了竹节管、竹节接头、方形硅胶罩，按照正确方式连接起来。

按如下所示连接上述部件：

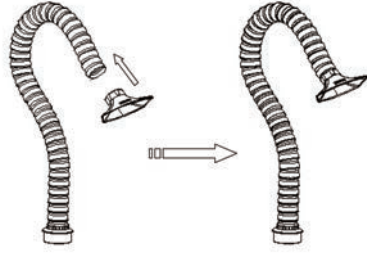

硅胶套安装示意图

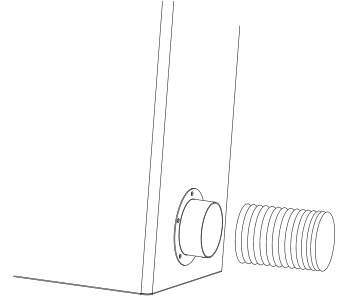

PVC导风管安装示意图

3. 取出烟雾净化器，放置在平整的地面或者台面上，带脚轮的机器需要锁紧脚轮刹车，避免产品震动或移动。
4. 将竹节管插入机器上盖的法兰孔中，转动管体，将喇叭罩对准烟雾产生的地方，距离尽量保持在20cm以内效果会较佳。

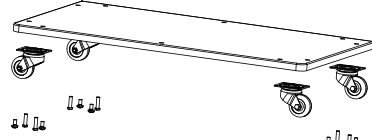

滚轮安装示意图

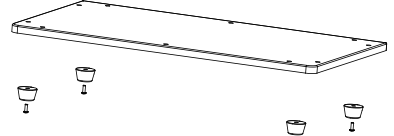

脚垫安装示意图

**操作说明 (ST-1101/ST-1202)**

**1. 连接电源开机**

将电源线插头插入相应标准的插座，推动船型电源开关按键通电。

**2. 风量等级调节**

转动旋钮开机（面板指示灯亮起）、调节风量等级。

**操作说明 (ST-1101D/ST-1202D)**



**1. 连接电源开机**

将电源线插头插入相应标准的插座，推动船型电源开关按键通电，点击面板电源开关按钮，LCD屏显亮起，进入开机界面。







正常工作界面

## 2. 风量等级调节

点击面板上  和  键来调节风量大小(风量等级范围1-100),短按一下往下/往上调节一个单位风量等级,长按按键快速的往下/往上调节风量等级;调节风量等级,屏幕显示的风量大小数据也会根据调节等级发生相应的变化。

## 3. 定时工作设置

短按  开启或关闭定时功能。

工作状态下,短按一次  按键,即进入定时工作时间设置,此时,显示器  图标闪烁,按  键和  键调节定时工作时间。(无操作后4S自动退出保存)







定时工作时间关闭



定时工作时间设置

## 4. 通讯连接地址码设置

工作状态下,短按  键进入地址码设置,此时  闪烁,短按  键和  键调节地址码。  
(无操作后4S自动退出保存)



通讯连接地址码设置

## 5. 报警功能

1. 过滤棉失效报警。当过滤棉使用饱和后,设备会发出滴滴报警声(声音持续11S),同时屏幕显示  闪烁,提示更换。此时,请及时检查并更换过滤棉或者检查其他设备问题。



2. 风机故障报警,当检测到风机部件故障后,屏幕  闪烁提示,并显示相关故障代码,产品发出滴滴声,在一定的时间内停止工作,此时需要检修风机故障原因。(显示F-E错误代码)

## 6. 解除面板锁定

长按面板  键5S面板锁定或解除面板锁定。短按遥控器  键面板锁定或解除面板锁定。

面板锁定后,面板按键和遥控器按键无法操作(除  键外)。

cannot be operated (except the  keys).

Long press  key on front panel for 5 seconds to lock or unlock the panel key.Short press  key on the remote control to lock or unlock the panel key. After the panel is locked, the panel keys and remote control keys

## 6. Panel Lock

period of time. At this time,please timely check the fan error reason and repair it. (display F-E error code)

relevant fault codes show up; the equipment will make an alarm sound and stop working within a certain 2. Fan fault alarm. When the machine detects a fan component failure, the screen display  flashes, and

replace the filter cotton or check other equipment problems.

meanwhile, the screen display  flashes to prompt for replacement. At this time, please timely check and 1. Filter failure alarm. When the filter is saturated, the equipment will make an alarm sound (lasts for 11S),

## 5. Alarm function

Communication connection address code setting

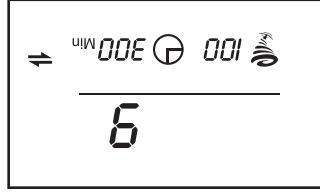

and  to adjust address code. (After 4s no-operation, it will automatically exit and save the data)

In the working state, short press  to enter address code setting. When  flashes, short press 

## 4. Communication connection address code setting

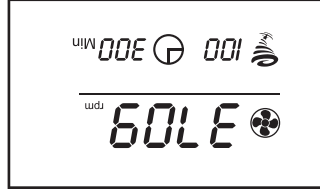

Set regular working time



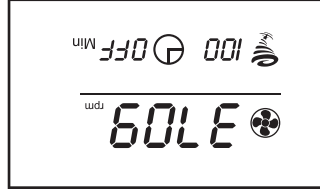

Close at regular working hours



exit and save the data)

flashes, press  and  key to adjust the fixed working time. (After 4s no-operation, it will automatically

In the working state, short press the  key to enter the fixed working time setting. When the display icon

Short press  to turn on/off timing function.

## 3. Timing work setting



### 7. Communication function

The host is equipped with RS485 interface, which can be connected with the computer, soldering station/hot air station for synchronous operation command.

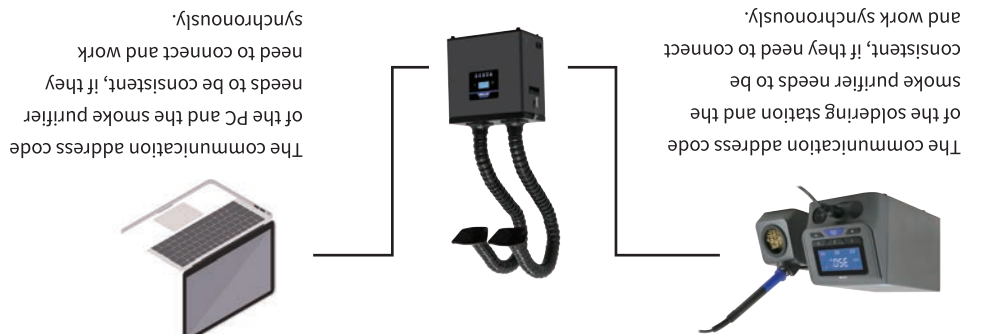

### Remote control layout and function

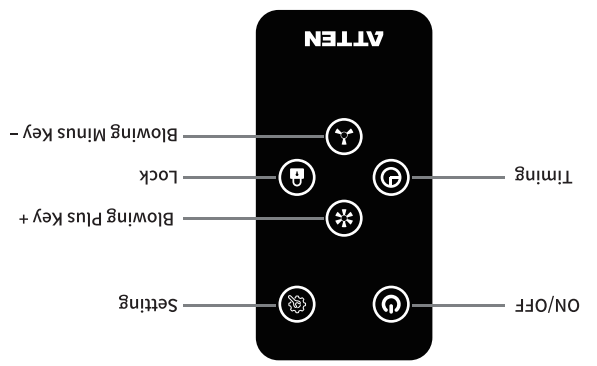

### Replacement and maintenance of filter

1. Due to the physical filtration mode adopted by this smoke purification equipment, the filtration device (primary effect filter, medium effect filter and main filter) has rated saturation. When the adsorbed dust, particles and other pollutants reach a certain degree, the filtering device will be blocked and lose the purification effect. At this time, it is necessary to replace a new filtering device to meet the filtering demand.

2. Judgments to replace the filter element: the various filters will require periodic replacement depending on the type of use the device is put to.

Primary filter - check and replace every 10-15 days usage.  
Medium efficiency filter - check and replace every 3-6 months usage.  
Main filter - replace every 6-9 months usage.

This data is only for reference, the filter element specific periodic replacement is mainly based on the use environment of each place.

### 7. 通讯联动功能

主机带有RS485接口可以与电脑、焊台、热风拆焊台连接同步操作命令。

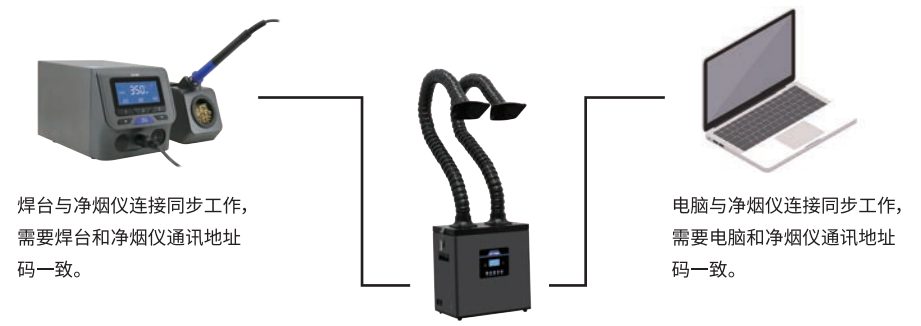

### 遥控器布局和功能

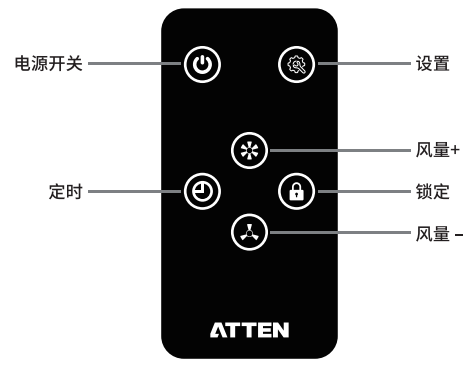

### 过滤装置的更换和维护

1. 由于本烟雾净化设备采用的物理过滤方式，因此过滤装置（初效、中效、高效）具有额定的饱和度，当吸附粉尘、颗粒等污染物达到一定程度时，过滤装置会堵塞，失去净化效果，此时需要更换新的过滤装置达到过滤需求。
2. 滤芯更换判断：本产品多次使用后产生的过滤装置更换周期建议如下：初效过滤棉使用周期10-15天；中效过滤棉使用周期3-6个月；高效过滤棉使用周期6-9个月，此数据仅供参考，主要依据各场所使用环境来进行具体周期更换。
3. 有以下情形时，则视为需要更换过滤装置：
  - A: 初效、中效过滤棉更换特征。设备吸力（流量）严重减弱；过滤棉变黄或变黑，表面肉眼可见许多颗粒；也可以依据使用周期定期更换。
  - B: 高效过滤棉更换特征：当设备报警或吸力严重减弱，排风口异味严重，首先检查初效、中效过滤棉，如更换初效、中效后还存在吸力小，异味重的情况则需要更新高效过滤棉。

#### 4. 过滤装置的更换步骤:

- A. 首先关闭工作中的设备, 切断外接电源, 拔掉吸烟管装置。
- B. 向上拉起两侧的搭扣, 取下上盖。
- C. 初效过滤棉更换直接揭去旧的过滤棉, 将新的过滤棉平铺中效过滤棉上即可

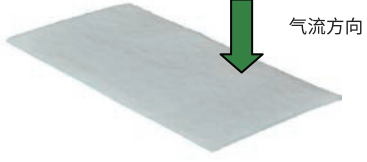

- D. 中效过滤棉更换拉住旧过滤棉的两侧的拉手, 缓慢平行的将其从高效过滤棉上拉出, 然后将新的中效过滤棉 (将手柄面朝上) 平整的缓慢压入, 用力压到其接触高效过滤棉为止。

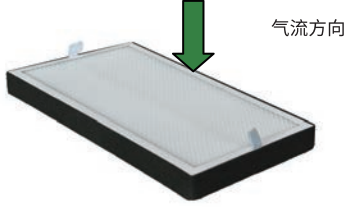

- E. 高效过滤棉更换在取出初效、中效过滤棉后, 更换新的高效过滤棉, 然后将中效、初效依次放入。

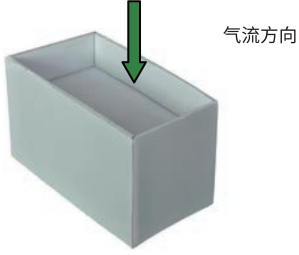

- F. 最后将上盖放在机身上, 注意要对应好, 然后挂上两侧的搭扣, 两边用力往下压, 锁紧搭扣, 接入吸烟管, 更换过程完成。

3. In the following cases, it is deemed necessary to replace the filter.  
A: Replacement characteristics of primary and medium efficiency filter. The suction becomes reduced. The filter turns yellow or black, and many particles can be seen on the surface; It can also be replaced regularly according to the filter cycle.  
B: Replacement characteristics of main filter. When the equipment gives an alarm or the suction is seriously reduced or the odor at the exhaust outlet is serious. Check and replace the primary and medium efficiency filter firstly, if the suction is still weak and the odor is still serious, the main filter needs to be replaced.

#### 4. Replacement steps of filter:

A. Replacement steps of filter:

B. Unlatch the two catches on both sides and remove the upper cover.

C. Replacement of primary filter element: remove the old cotton filter and replace with a new cotton element laid flat onto the medium filter element.



flat onto the medium filter element.

D. Replacement of medium efficiency filter element: hold the tab on both ends of the medium-efficiency filter element and gently pull it out of the recess in the high efficiency filter. Replace the new element with the tabs uppermost



E. Replacement of high efficiency filter element: After removing the primary filter and medium efficiency filter, extract the main filter by holding it at both ends and gently pulling upwards. Replace with a new main filter inserted into the device, then insert the medium effect filter and the primary filter in turn.

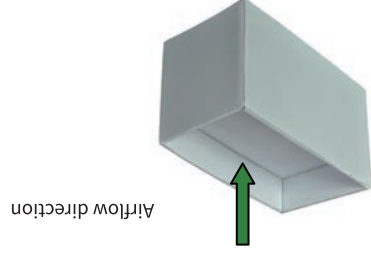

F. Finally, put back the upper cover, latch the two catches on both sides, re-attach the flexible tubes to finish the replacement process.

This product test result is qualified and met the technical standard.

Product Certification	Product warranty card
Product Model: _____	This product is guaranteed for two years from the date of purchase.
Product NO.: _____	If any quality problem is found within the guarantee period, we will response for the maintenance free of charge on presentation of this card and the receipte.
Inspector: _____	Note: This warranty card must be attached when this product is returned to the factory for maintenance, otherwise free maintenance will not be accepted.
EX-Factory date: _____	Thank you for your cooperation!
Salesperson: _____	
Sold Date: _____	

产品保修卡	产品合格证
本产品保修期自购买日起，两年内有效，凡属产品质量问题，凭此卡及收据由本公司负责免费维修。	产品型号: _____ 产品编码: _____
注：本产品返厂维修时，必须附上保修卡，否则将不予以免费维修，谢谢合作	检 验 员: _____ 出厂日期: _____
	售 货 员: _____ 售货日期: _____

本产品经检验符合技术标准产品合格

## 深圳市安泰信科技有限公司

- 单支烙铁
- 恒温电焊台
- 热风拆焊台
- 多功能维修系统
- 直流稳压电源
- 直流开关电源
- 可编程电源
- 焊锡烟雾净化器

MADE IN CHINA

Email: sales@atten.com.cn

Web: www.atten.com

Tel: +86-755-2697 6181

Guangming District, Shenzhen 518132, China

SHENZHEN ATTEN TECHNOLOGY CO.,LTD.  
Add: 8 Floor, Building 2, Senyang High-tech Park, No. 7 Road,  
Guangming District, Shenzhen 518132, China

## 深圳市安泰信科技有限公司

SHENZHEN ATTEN TECHNOLOGY CO.,LTD

地址: 广东省深圳市光明新区七号路森阳高新科技园2栋8楼

电话: 0755-8602 1389 (总机) 0755-8602 1370

网址: www.atten.com.cn (中文) www.atten.com (英文)

邮箱: sales@atten.com.cn 邮编: 518132

MADE IN CHINA

CBN034868(D)

SHENZHEN ATTEN TECHNOLOGY CO.,LTD.

● Soldering Iron ● Soldering Station ● Hot Air Rework Station

● Multi-function Rework System ● Switching DC Power Supply

● Regulated DC Power Supply ● Solder smoke purify machine

● Programmable Power Supply